

1	2	3	4
RevNo	Revision note	Date	Signature
			Checked

A
B
C
D
E
F

A
B
C
D
E
F

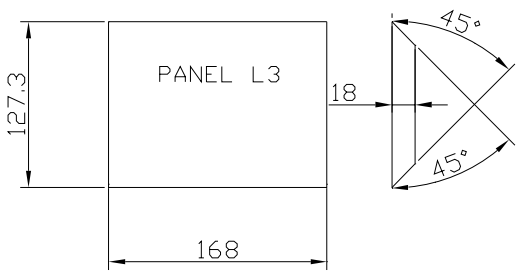
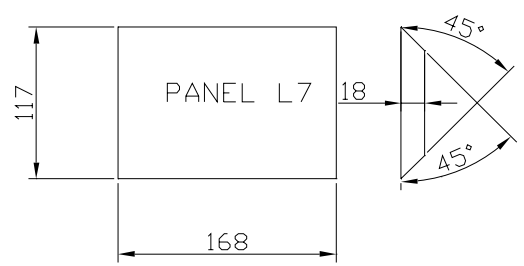
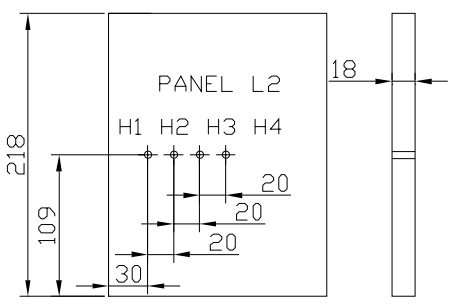
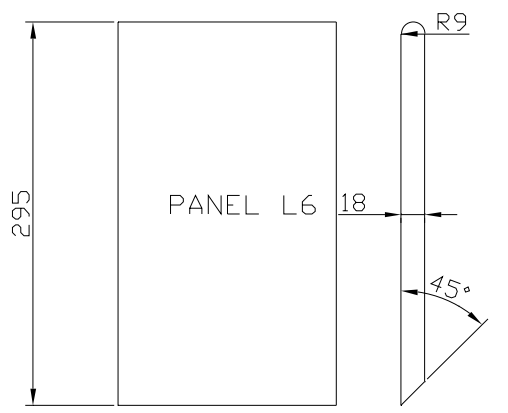
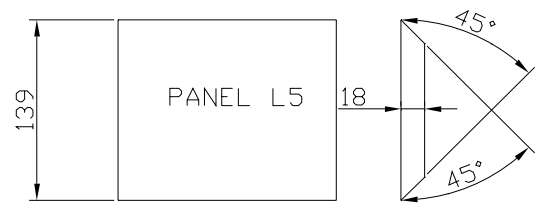
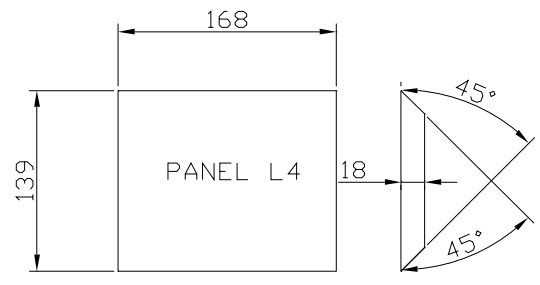
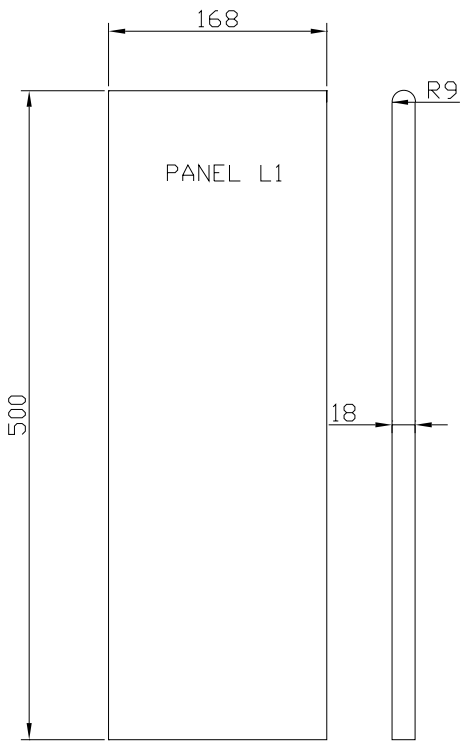

Notes H (1-4) = 5.2 Diam for 612 strand \square FC all copper.
 \square R
H (1-2) = 5.2 Diam for 612 \square FC copper.
H (3-4) = 3.9 Diam med spkr Cable Silver plated.

Itemref	Quantity	Title/Name, designation, material, dimension etc			Article No./Reference	
Designed by B. J. Adams		Checked by	Approved by - date	Filename See below.	Date 23/03/2001	Scale NONE
QTA SYSTEMS				TL1/2 SMALL PANEL DRAWINGS		
				MFACTTL12_SMP1.DWG	REV 00	SHEET 10/11